

subnado PLUS

USER GUIDE | MANUAL | SAFETY

V2.0 2025.05

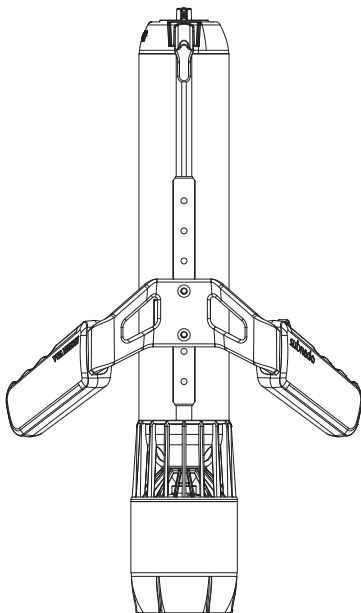

WYBOD

Contents



Read and understand this user manual and all safety instructions before using this product.

I Disclaimer	02
II Overview	03
2.1 Safety Guidelines	03
III Waydoo Subnado	05
3.1 Product Diagram	05
3.2 Product Specifications	05
IV Charging	06
4.1 How to charge Subnado	06
4.2 Reverse charging function	07
V Assembly Steps	08
VI Accessories Use Instruction	09
VII How to use	17
VIII Product Specifications	20
IX Error and Tone Indication	21
9.1 Error indication and solution	21
9.2 Tone Indication	23
X Maintenance	24
10.1 Cleaning after use	24
10.2 Storage	24
XI Warranty Terms	25

I Disclaimer

Please fully read this product manual and related warnings and Safety Guidelines carefully before use. Please fully understand your legal rights, responsibilities, and safety instructions. This product is an underwater scooter. Improper use may cause the risk of severe injury or death. USE THIS PRODUCT AT YOUR OWN RISK. Users must understand and accept the inherent risks of using this product. Any misuse of this product may cause personal injury or property/product damage. When using this product, please be sure to use original accessories or Waydoo certified accessories. By using this product, you are deemed to have accepted the terms and content of this document in its entirety. Users are responsible for their actions and all consequences. As the developer of this product, Waydoo reserves the right to change components, specifications, or other information without prior notice. For the latest information, please visit www.waydoo.com

WARNING: Minors under 16 year of age must be good swimmers and accompanied by a competent guardian who is fully familiar with this product and this manual, including the Safety Guidelines. The Safety Guidelines contain only partial knowledge of operating safety and must be understood in connection with general safety knowledge and common sense. Please be sure to carefully read the Disclaimer's contents and the Safety Guidelines. Read the user manual carefully to familiarize yourself with the product's functions before use. Failure to operate this product properly may cause serious injury to yourself or others and damage the product and property. This product requires users to be fully familiar with it before use. Users need to learn about the product before operating. Never use any parts that are damaged, in need of maintenance or not supplied or recommended by Waydoo. Please strictly follow Waydoo instructions for installation and use. This document contains safety instructions, operation information, maintenance, etc. Please be sure to read all instructions and warnings carefully before assembling, setting up, and using.

FCC Cautions:

This device complies with part 15 of the FCC Rules .Operation is subject to the following three conditions:

- (1)This device may not cause harmful interference.
- (2)This device must accept any interference received,including interference that may cause undesired operation.

Shenzhen Waydoo Intelligence Technology Co.,Ltd.

MADE IN CHINA

- (3)Changes or modifications to this unit not expressly approved by the party responsible for compliance could void the user' s authority to operate the equipment.

II Overview

2.1 Safety Guidelines

- ▶ Failure to follow these Safety Guidelines and warnings may result in serious injury or death.
- 1) Minors under 16 year of age must be accompanied by a guardian when using this product.
- 2) Please refer to the user manual and watch the tutorial videos carefully before using this product.
- 3) Do not use this product if you are under the influence of alcohol/drugs, or not physically or mentally fit for swimming, snorkeling, diving, or other water sports.
- 4) Keep the product away from fire. Avoid heavy pressure, squeezing and dropping.
- 5) Only operate this product underwater. Do not let the motor run in the air for more than 10 secs.
- 6) The ambient temperature for using this product is 0°C ~ 40°C (32°F ~ 104°F). The ambient temperature condition of storage is -10°C ~ 50°C (14°F ~ 122°F). Keep this product in the shade when not actively using it.
- 7) Please be sure to keep your fingers, hair, clothes, swimwear, drawstrings, necklaces, jewelry, netting and loose or dangling items away from the propeller during use to avoid personal injury or product damage.
- 8) Do not use this product in waters with a lot of mud, sand, debris, seaweed and algae, and floating objects to prevent foreign objects from getting into the propeller and damaging the power unit.
- 9) Before use, please pay attention to the water conditions. Make sure that the water is suitable for water sports activities and for using this product.
- 10) Before using the product, check carefully whether the product is broken, the waterproof cover is in place, and that the propeller is working normally.
- 11) When using this product, it is recommended to wear a swimming cap or helmet, avoid wearing loose clothing, and keep a safe distance from others, especially those with long hair or wearing loose clothing.
- 12) When using this product, please hold the Handle Bracket tightly and not point the front or tail at face, especially the eyes.
- 13) Do not use a damaged or defective product.
- 14) Do not use this product until you fully understand the operating procedures and inherent risks.
- 15) This product contains batteries and intricate integrated circuitry, which means users are not allowed to disassemble or repair it personally to avoid short-circuiting, electric-shock and fire.
- 16) This product is not a substitute for, or aid in, basic swimming ability.

⚠WARNING This product contains an internal lithium-ion battery and therefore encompasses an inherent risk of fire, explosion and/or burns, including chemical burns. Inspect product housing for damage before charging. Never charge product if damaged, or placed near heat or attempt to open the housing/battery compartment. Never charge the battery while it is in, or near, water. Always ensure that the battery connections are dry. Avoid excessive vibration bumping or collision. Keep this product away from volatile substances, acidic materials, sharp objects, or placed under heavy objects. Disposal of products containing lithium-ion batteries require special handling that must be done in accordance with local laws and regulations. Never placed this product in a fire or furnace.

- ▶ This is not a lifesaving device or buoyancy aid. Use appropriate equipment such as a wetsuit, approved life vest vest or personal flotation device, and mask when using this product. Check the remaining battery life often so you can return to shallow water before losing battery power.
 - ▶ Make sure you have a companion or spotter when using this product.
 - ▶ When using this product, pay attention to the surrounding environment and maintain safe distance from watercraft, other people, animals, plants, obstacles, toys recreational equipment, or floating objects. Do not use this product in bad weather, strong offshore winds, or around hazardous waters, such as riptides, or undercurrents.
- ⚠**If the user lets go of this product during use underwater, it will sink.

III Waydoo Subnado

3.1 Product Diagram

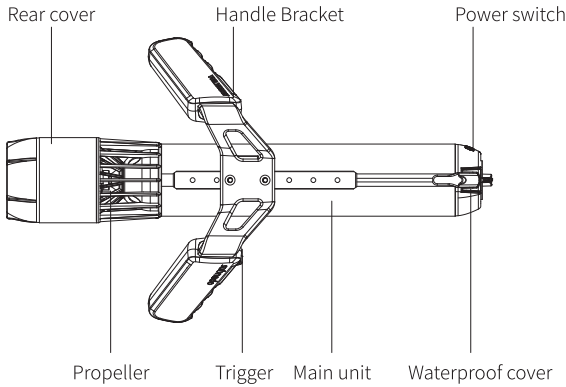

3.2 Product Feature

◆Two-speed thrust: The high and low gear provides two-speed thrust options. Users can switch to the high or low gear by pressing the trigger twice quickly. Users will hear one beep if they successfully switch to low gear or two beeps if they switch to the high gear.

◆Super gear: Quickly press the trigger three times. When hearing three beeps, users successfully switch to super gear; Within 150s, press the trigger to start the propeller. The propeller will spin at the maximum speed and provide the ultimate thrust.

Note: After 150s, the unit will automatically exit Super gear and switch to the gear before Super gear. To re-enter Super gear, quickly press the trigger again three times.

Note: The battery SOC should satisfy a specific range to enter the setting gear. (refer to table 1)

Gear	Battery SOC requirement
High gear	>25%
Super gear	>37.5%

table 1

Note:

1. When the battery SOC is below 25%, it will automatically switch from high gear to low gear. When the battery SOC is below 37.5%, it will automatically exit super gear and switch to high gear.

2. When the waterproof cover is not installed, the main unit will issue an alarm to remind you, preventing you from forgetting to install it before entering the water.

◆**USB-C Fast Charging:** Use a USB-C charger (compatible with PD3.1/QC3.0 and downward-compatible) to charge the Subnado, with a maximum charging power of 140W.

(Note: It needs to be supported by the charger and use of an 140W capable charging cable to reach the maximum charging power).

◆**Reverse charging:** Use the main unit as a power source to charge other devices. Compatible with PD3.1/QC3.0 or lower versions. Maximum reverse charging power up to 140W.

(Note: It needs to be supported by the charging device and use of the e-Mark charging cable to reach 140w charging power)

For a list of compatible chargers tested by Waydoo Lab., please refer to <https://waydoo.com/pages/support>

◆**Cruise Control Mode:** In this mode, if the throttle trigger is held down continuously for 15 seconds and then released, the propeller will automatically maintain a constant speed. The user does not need to keep pressing the trigger during operation.

◆**Enabling Cruise Control Mode:** To enable cruise control mode, hold down the throttle trigger first, then power on the main unit. Turning off or restarting the main unit will disable cruise control mode.

◆**Entering Cruise Control Mode:** In cruise control mode, after holding the throttle trigger for 15 seconds, the system enters cruise mode. The motor speed changes at the moment of activation to indicate entry, and the main unit's power indicator starts flashing. The trigger indicator light switches to breathing mode. Turning off or restarting the power will exit cruise mode.

◆**Idling protection status:** No-load Protection Mode: Subnado will noticeably slow down after running in the air for a few seconds to protect the motor. Idling protection will not be triggered when the device is working underwater.

Note: Idling protection will continue to be in effect if Subnado is entering cruise mode in the air.

IV Charging

4.1 How to charge Subnado

1. Use a high-power charger that supports the PD/QC protocol to speed up charging.

2. Open the waterproof cover (facing down to prevent water from falling in). Check for moisture around and inside the USB-C port. If there is water, it needs to be dried first; if there is seawater, it must be thoroughly cleaned with alcohol. After confirming that there is no abnormality, insert the USB-C charging cable to start charging.

3. During the charging process, the power indicator is displayed circularly in the form of a marquee, and the number of lights indicates the current power.

4. The speed of the marquee indicates the charging speed; the faster the marquee speeds, the faster the charging is.

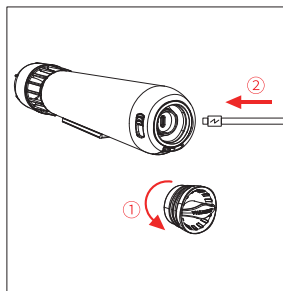

4.2 Reverse charging function

1. Open the waterproof cover (make sure that no water enters inside the USB-C plug or remains on the surface).
2. Power on the Subnado first, then plug in the USB-C cable. Connect the cable to the target device, charging begins. (Note that Subnado needs to be powered on before connecting the device)
3. After charging is completed, unplug the charging cable and turn off the Subnado.
4. Install the waterproof cover.

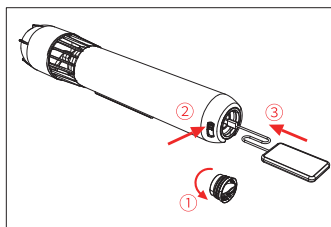

4.3 Waterproof cover installed securely in place.

The waterproof cover keeps water from entering the USB-C port. Improper installation or lack of grease may cause water to enter the USB-C port, and damage to the USB-C port. Apply grease to the waterproof cover to ensure proper sealing. Be sure to install the waterproof cover securely, as shown in the figure.

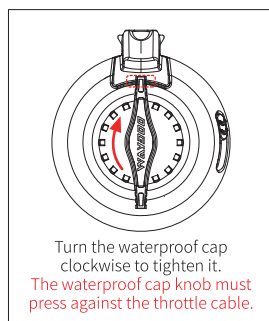

4.4. Reference Charging Time

Reference Charging Time

10W Charger	approx. 15hours	24W Charger	approx. 7.5hours
36W Charger	approx. 5 hours	65W Charger	approx. 2.8hours
100W Charger	approx. 2 hours	140W Charger	approx. 1.2hours

Trigger light signals

White solid : Locked state	Red solid/blinking : Super gear / Super gear running
Green solid/blinking : Low gear / Low gear running	Yellow solid/blinking : Low battery / Communication failure
Blue solid/blinking : High gear / High gear running	Breathing : Cruise control

V Assembly Steps

5.1 Install the handle bracket on the main unit, and make sure the Wired Thumb Controller interface aligns with the correct position. (Take the handle bracket as an example, The Quick-release Clamp vary based on different product configurations)

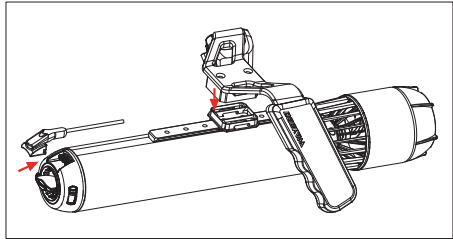
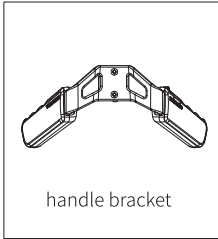

5.2 Instructions for grease

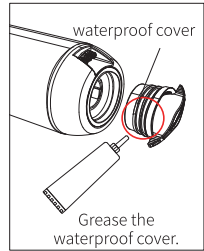
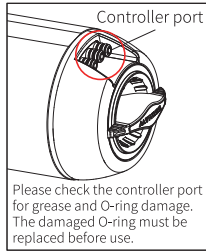
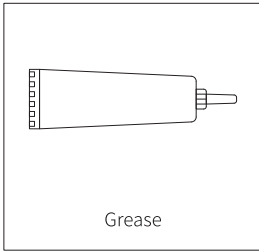

The throttle cable connector is designed to be waterproof to prevent water from entering the internal interface. If water enters the connector, it may result in the following issues. Moisture presenting in the connector port may cause: 1. The motor to run nonstop when the Subnado is switched on. 2. Nonconductive connector or even permanent damage to the Subnado due to corroded connector pins or contacts. Therefore, keeping the connector port dry is critical to using the Subnado.

Please carefully read and follow Waydoo's official checklist and maintenance notes to ensure optimal user experience and product longevity.

Before connecting the controller, please check:

- (1) Check whether there is water inside the connector. If so, clean it with fresh water or alcohol, then dry it with a cotton swab or tissue, and allow it to air dry before use.
- (2) Check the lubricant condition on the connector's O-ring. If the lubricant is insufficient, add more about 2–3 mm in length is recommended. After inserting and removing the connector several times, check whether the throttle cable plug can be installed properly. If it cannot be fully inserted, it may be due to excessive grease, and some of it should be removed.

(3) Check whether the O-ring at the connector position is damaged. If it is damaged, please replace the O-ring to enhance waterproof performance.

(4) When inserting and pressing the throttle cable plug, you should feel a rebound force due to air compression, indicating a good seal. Otherwise, check if the O-ring is damaged or if there are any foreign objects on the inner surface of the throttle cable plug.

Notes:

1. If the Subnado is irresponsive after grease application, please consider the following causes and fixes:

(1) Cleaning the corroded copper contacts, if any.

(2) Too much grease to install in place.

(3) Replacing the wired controller if the connector pins are corroded.

2. Please check and apply grease to the O-rings around the waterproof cover to maintain waterproofness.

3. Please unplug and check the wired controller after each use. Please clean and dry the connector if moisture is present inside.

VI Accessories Use Instruction

6.1 Arm Mount Installation and Usage Instruc-

1. Use two M4X8 screws to connect the handle to the arm mount.

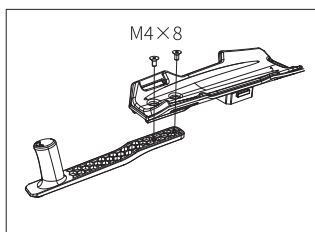
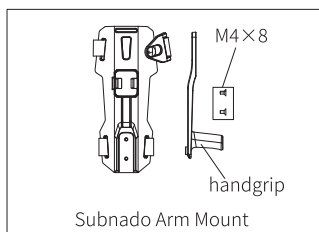

2. Once assembled, refer to the diagram below.

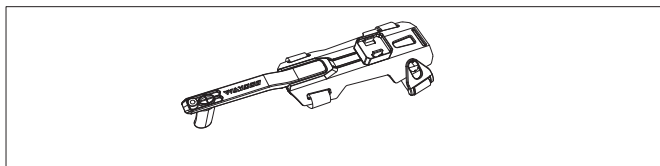

3. Hold the handgrip and place the Arm mount on the outside of the forearm. Wrap the strap around the forearm 1-2 times, depending on the arm circumference.

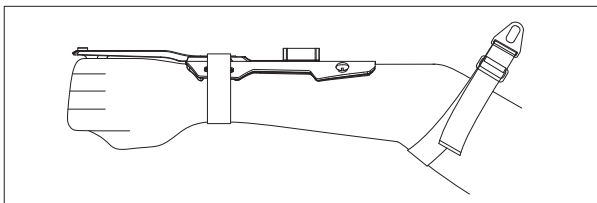

4. Fasten the gourd buckle on one end of the strap.

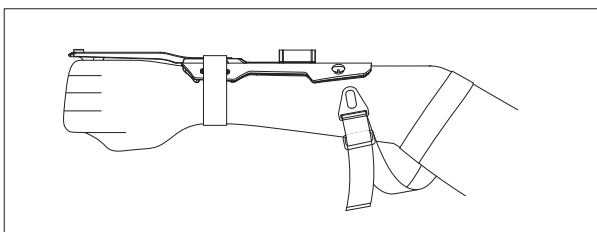

5. According to the forearm circumference, wrap it 2-3 times and finally fix it with nylon tape.

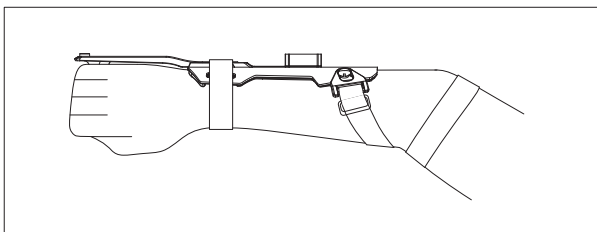

6. Install the main unit to the Arm mount through the quick release part.

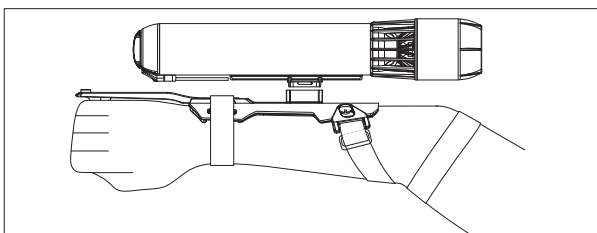

6.2 Leg Mount Usage Instructions

1. Fix the Subnado leg mount to the outside of the leg. Install the main unit to the leg mount through the quick release part.

Note:Please use the specially designed straps for the leg mount.

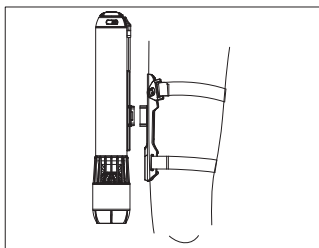
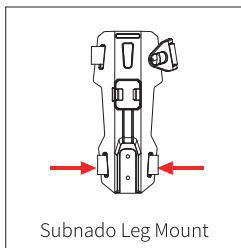

2. Fasten the belt around the waist. Pass the straps on both sides of the waist belt through the holes above the leg mount, and then fix them with nylon straps.

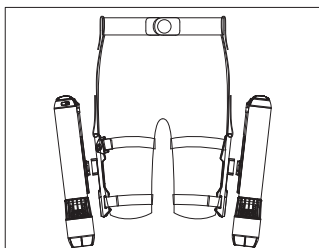
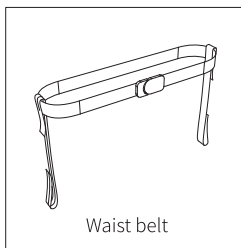

6.3 Cylinder Clip Usage Instructions

Insert the bottom plate of the cylinder clip through the cylinder strap. Tighten the cylinder clip screw so that it is fixed on the cylinder. Subnado main unit can be installed on the cylinder clip through the quick release part.

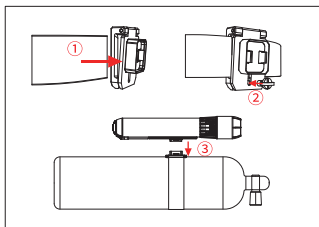
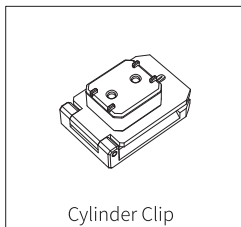

6.4-Wrist Strap Usage Instructions

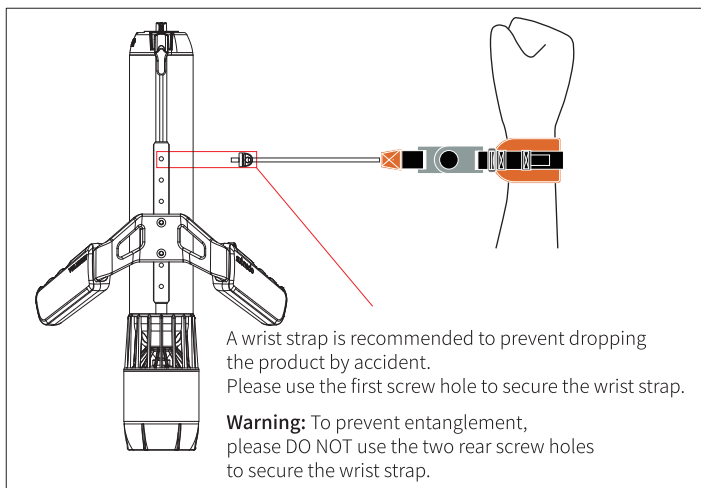

6.5 Installation steps for Subnado Water Cannon Kit.

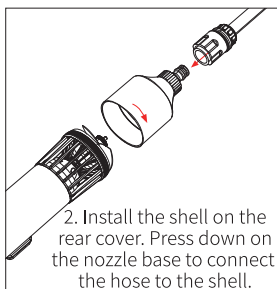
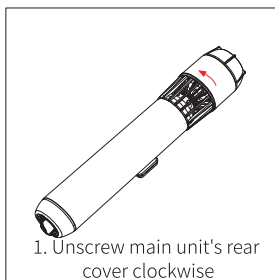
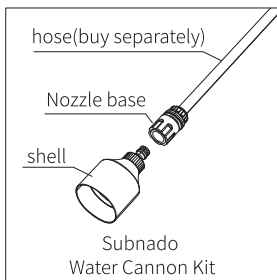

Note: Please turn clockwise and apply force to the unit first. After you feel the obvious two consecutive sudden jumps, it means that the thread is in the best installation position. At this time, apply appropriate force along the motor axis and rotate the shell counterclockwise. Otherwise, it is easy to fail to install or to install crookedly.

6.6 SUP Slide-in Fin Box Mount & Locking Clip Usage Instructions

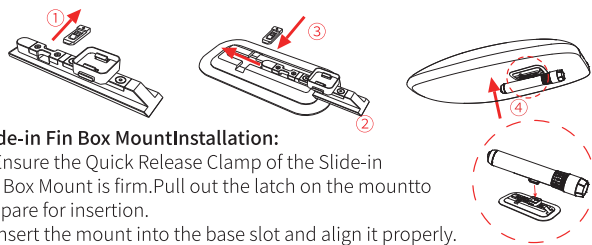

Slide-in Fin Box Mount Installation:

1. Ensure the Quick Release Clamp of the Slide-in Fin Box Mount is firm. Pull out the latch on the mount to prepare for insertion.
2. Insert the mount into the base slot and align it properly.
3. Reinsert the latch to secure the mount.
4. Align Subnado with the mounting base, press until it clicks, and ensure it is firmly attached and stable.

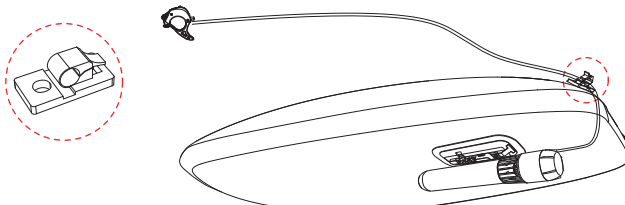

Controller Wire Clip Installation

1. Please confirm that the surface is clean and even before installation. Please wipe off any dirt or dust, and keep the surface dry.
2. Peel off the protective liner on the controller wire clip's adhesive pad, attach the clip to the board and firmly press it to ensure a tight bond.
3. Let the adhesive cure for half an hour to get a stronger bond. Please gently rock the clip to check the adhesion security before entering the water.

6.7 Accessories Mount Usage Instructions

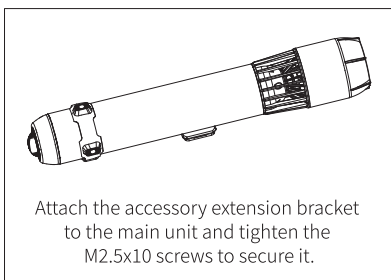
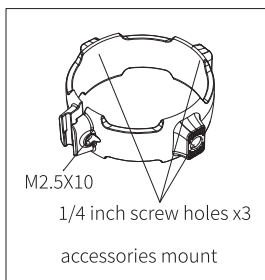

6.8 Twin Engine Handle Bracket Usage Instructions

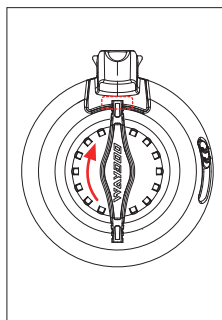
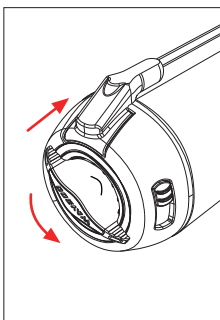
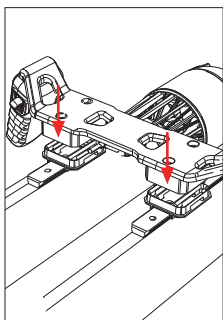

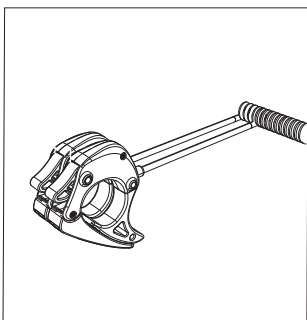

Align the two tiny prongs on a trigger with the round holes of the other trigger, and close them horizontally.

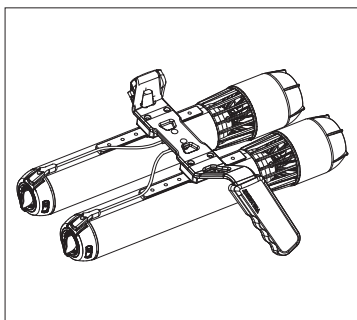

Installation complete.

Note: 1. It needs to be installed in a water-free environment, avoiding water at the connection points. If water is present, it should be dried. You can clean it with clean water or alcohol, then wipe it dry with a cotton swab or paper towel, and allow it to air dry before use.

2. Please fully charge the Subnados before use to avoid imbalanced performance.

3. Before using the Twin Engine Handle Bracket, it is recommended to assemble two main units. The plug cable should not be submerged in seawater alone, as this will cause the copper pins of the plug cable to corrode, resulting in the connector being unable to conduct properly and function correctly.

4. Please ensure the Subnados are on the same gear during operation to prevent imbalanced thrust output.

6.9 Finger Protection Cover Usage Instructions

If the users' fingers are relatively slender and are worried about injury during use, they can install the finger safe-guard. The following are the installation steps: (Note: Using a finger safe-guard will increase water resistance, resulting in increased power consumption which affects efficiency and reduces battery life and thrust)

a. Please turn off the main unit first. Unscrew the rear cover of the main unit clockwise, remove the O-ring, and take off the propeller.

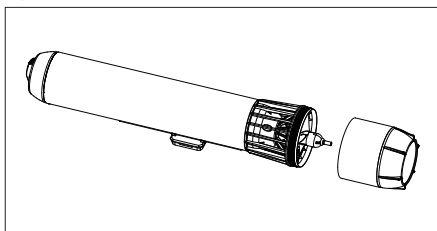

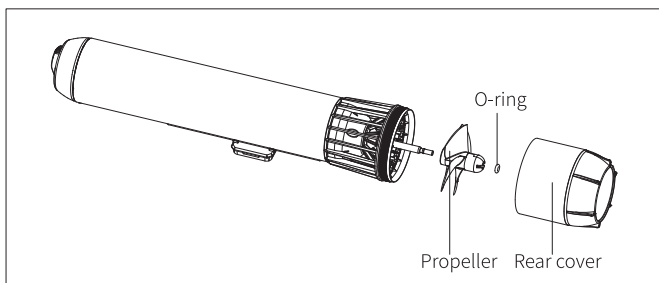

b. Remove the pin

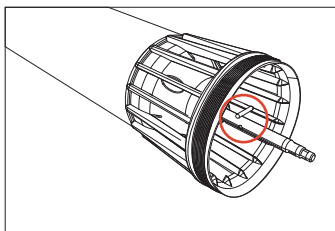
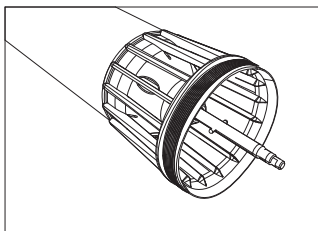

c. Put the finger safe-guard into the groove, press each end of the finger safe-guard into place, and make sure the end of the finger safe-guard is engaged with the notch in the groove (as shown in the figure)

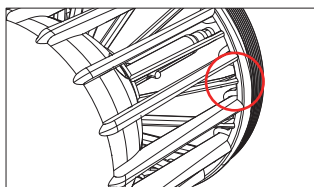
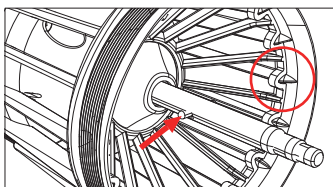
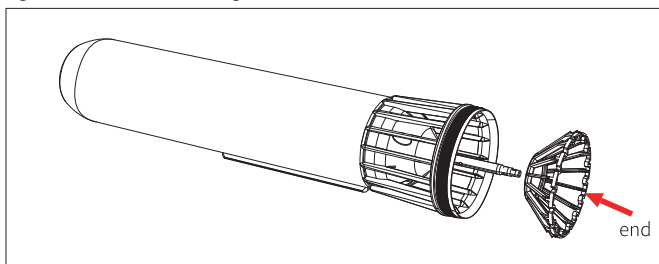

d. Check the condition of the pin grease. If the grease is insufficient, add grease as needed. Then, correctly position the pin and assemble the propeller.

e. After installing the O-ring, check the grease condition. In case the grease is insufficient, please add grease to the optimal amount. Align the rear cover center with the shaft and tighten the rear cover counterclockwise.

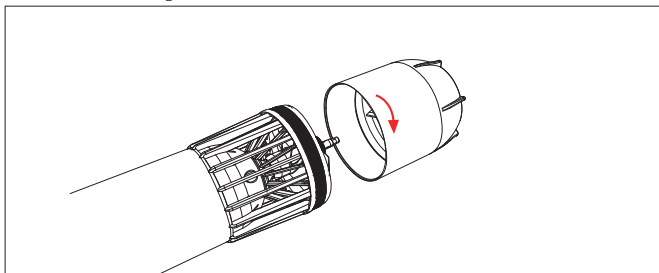

For assembling and using other accessories, please refer to the relevant documents on the official website. www.waydootech.com

VII How to use









This product requires users to be fully familiar with it before use, and users need to have basic knowledge before operating. Waydoo hereby strongly recommends that users read and follow each of the steps before use.

1. Check if the waterproof cover is in place (refer to IV - Charging).
2. Check if there is water in the plug, as well as check the grease condition (refer to the installation steps).
3. Turn on the main power and check the battery level (refer to Figure 1). After the Subnado powers on, double-click the controller trigger to unlock the controller. Also, check if the main unit's self-test sound is normal (refer to section 8.2) and whether the cruise control is enabled.
4. Press the trigger to confirm normal function, and to check if the throttle control is good.
5. High or low gear can be set with quickly pulling the trigger twice. Quickly pull the trigger three times to engage Super gear. The number of beeps indicates the gear selected. "One beep" prompts to enter the low gear, "Two beeps" to enter the high gear, and "Three beeps" to enter the Super gear.

(Note: The Super gear only maintains for 150s. To re-enter Super gear, you need to press the trigger 3 times quickly.)

It supports two modes: Cruise Control Mode (refer to Figure 1) and Normal Mode (refer to Figure 2).

Figure 1

LED Light	Capacity
	<8%
	8%-18%
	18%-25%
	25%-37.5%
	37.5%-50%
	50%-62.5%
	62.5%-75%
	75%-87.5%
	87.5%-100%

Note: All of the above and below half-segment LED lights represent the flashing LED lights.

Figure 2

Mode	Cruise mode
Power-on indication	
	8 LED lights flash once and shows the battery power level
How it works	Under cruise mode, the propeller rotates when pressing the trigger. After 15 seconds, when there is a transient speed change, it enters auto cruise. Users can release the trigger, and the propeller will continue rotating. Press the trigger again, and the propeller will stop rotating and exit the auto cruise.

Figure 3

Mode	Regular Working mode
Power-on indication	
	8 LED lights flash twice and shows the battery power level
How it works	Under regular working mode, the propeller rotates when pressing the trigger and stops after releasing.

VIII Product specifications

Subnado	Product weight	About 1.8kg
	Product diameter	About 397*60mm (propeller cover:70mm)
	Maximum speed	1.7m/s
	Maximum depth	60m
	Battery life (maximum)	60mins
	Operating temperature	0°C~40°C (32°F~104°F)
	Maximum thrust	9.3kg (Super gear)
	Accessories Mount	support three 1/4 inch threaded mounting holes
Charging	Charging voltage	5V~28V
	Plug type	USB-C
	Maximum power	140W (PD3.1)
	Charging temperature	0~40°C (32°F~104°F)
	Charging time	1.2H (140W)

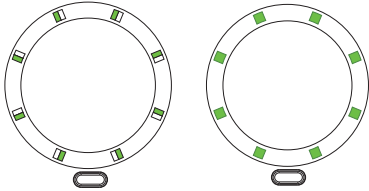
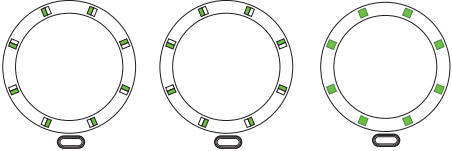
Firmware Upgrade:



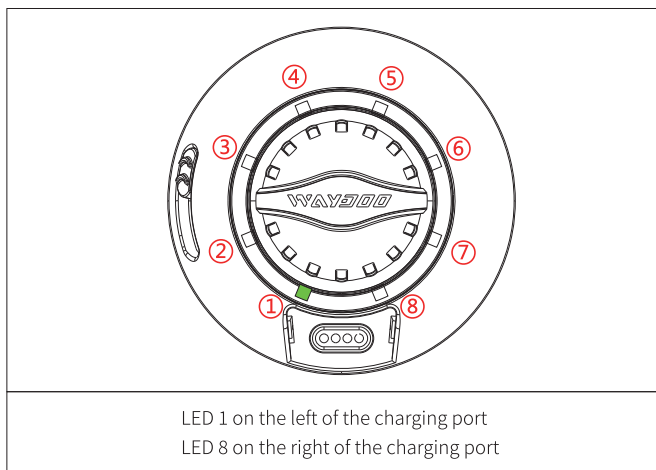

By downloading the Subnado Upgrade Tool from Waydoo official website's "Download" page, users can upgrade Subnado to the latest firmware for better product experiences.

IX Error and Tone Indication







9.1 Error indication and solution

Fault Indicator (From left to right, it is ①~⑧)	Fault	Solution
	Charging Overtemperature	<ol style="list-style-type: none"> 1. Stop charging. 2. Place the main unit in an environment with a lower room temperature, and wait for the main unit temperature to drop to a suitable temperature, and the fault will disappear.
	Cell over- temperature	<ol style="list-style-type: none"> 1. Stop charging 2. Place the main unit in an environment with a lower room temperature, and wait for the main unit temperature to drop to a suitable temperature, and the fault will disappear.

Fault Indicator	Fault	Solution
	Battery Over-discharge	Please contact Waydo support team.
	Motor Communication Failure	Update the firmware
	PD Communication Failure	<ol style="list-style-type: none"> 1. Use recommended chargers that meet the published charging protocol requirements, such as a charger that supports PD/QC protocol. 2. If the problem cannot be solved with a new charger, please contact Waydo support team.
	MCU Overheat	<ol style="list-style-type: none"> 1. Please shut down the device immediately. 2. Place the device in a low temperature environment, and wait for the device to cool down, and the fault light disappears.
	Charging Overcurrent	<ol style="list-style-type: none"> 1. Please disconnect the charger immediately to avoid further damage. 2. Please check that the charging cable, charger and USB-C interface are normal, reconnect the charger and try to charge the Subnado.

Note: All of the above and below half-segment LED lights represent the flashing LED lights.

9.2 Tone Indication

Tone	Indication
♪ 1 2 3 4 5 6 7	Main unit Self-checking passes
	Gear switch: One beep indicates switching to low gear; Two beeps indicates switching to high gear; Three beeps indicates switching to super gear
	Unable to enter the setting gear
	Remind users to power off the main unit to avoid running out of power (not pressing the trigger within 15 minutes / not charging or charging complete)
	Every 5 seconds, a double beep will sound to remind the user to attach the front cover.

X Maintenance

Improper maintenance, disassembling and repair may cause damage to this product, personal injury, including electric shock, and be deemed a waiver by the purchaser, owner and user of the product warranty as noted in the Warranty Terms and Limitation of Liability sections of this manual.

10.1 Cleaning after use

After each product use, please follow the guidelines to rinse the product to maintain the corrosion resistance and extend the product life. Please follow the principles below:

- 1) After using the product in seawater, please be sure to rinse the whole unit with fresh water and dry it in time to avoid corrosion of the exterior and discoloration of the body.
- 2) Before rinsing the body with fresh water, please ensure the waterproof cover is tightened.
- 3) Always check that no stones, salt, sand, or dirt get into the Subnado when cleaning parts such as connecting parts, propellers, etc. Please clean up those objects which are within easy reach regularly if necessary.
- 4) If you find any foreign objects wrapped around the propeller, carefully remove the main unit's rear cover and clean.
- 5) After finishing the cleaning of the main body, please remove the waterproof cover and clean the charging port with clean and dry cotton swabs to ensure that there is no water, sand, or other foreign objects.
- 6) Please dry the main unit before removing the waterproof cover to avoid seawater dripping inside and damaging the USB-C port. If some water gets into the charging port, dry it in time.
- 7) If seawater drops in the connector of the wired thumb, use a little fresh water or alcohol to clean it and dry it in time to avoid poor contact caused by corrosion which will affect the subsequent use of the product.
- 8) If the oxide layer of the shell is accidentally damaged, it should be repaired in time to avoid accelerating the corrosion of the shell.

10.2 Storage

Please follow these storage guidelines:

- 1) Please ensure the power switch is off and keep the product away from strong magnetic environments, which may power on the main unit and consume battery power.
- 2) Please ensure that the storage temperature is within the range of $-10^{\circ}\text{C}\sim 50^{\circ}\text{C}$.
- 3) Do not store Subnado in humid, direct sunlight and other harsh environments that may cause damage to electronic devices.
- 4) Do not place Subnado in open flames, and please keep out of reach of minors under the age of 16.
- 5) Please prevent the battery from being over-discharged due to prolonged non-use before storing the Subnado.
- 6) If you do not use the product for a long time, you should make sure that the power level is between 50% and 62.5%. At the same time, the unit needs to be charged every three months (charged to 50~62.5%).

XI Warranty Terms

Limited Warranty

Under this limited warranty policy, Waydoo warrants the original buyer for the warranty period that the product will be free from material and workmanship defects under normal use in accordance with Waydoo Subnado's published product materials. The warranty period is ONE (1) YEAR for specific parts starting from the date you received products. The repair or replacement of parts, under this warranty, does not extend the life of this warranty beyond its original expiration date. Please refer to Appendix I for the specific coverage period on each part. If you cannot provide a receipt or other valid proof of purchase, the start date of the warranty period will refer to the dispatch date of the Waydoo products, unless otherwise stipulated by Waydoo.

How Do I Get After-Sales Service?

If a product does not function as guaranteed during the warranty period, you may obtain after-sales service by contacting your local authorized dealer or Waydoo After-Sales Support Team. The e-mail address for after-sales service is support@waydootech.com.

Waydoo may not provide after-sales service in some regions. The after-sales service policies may vary from region to region. Charges may apply for services not covered by this Limited Warranty. For information specific to your location, please contact Waydoo or your local authorized dealers.

Request For Warranty Service

Waydoo offers the following warranty services. For more information, please contact Waydoo or an authorized Waydoo dealer. Users may also need to fill out a product warranty card and return the product to be repaired to Waydoo Official or an authorized Waydoo service center with the warranty card, if necessary.

- 1) Fill out and submit a Warranty Claim Form. Please provide as many photos and videos as possible to help Waydoo AFS accurately assess your request.
- 2) Once your request is received, Waydoo AFS will contact you via e-mail to offer troubleshooting instructions or request further information.
- 3) Waydoo AFS will get back to you via e-mail with instructions on what to do next, depending on their findings.

What Should I Do Before Getting Warranty Service?

When reaching out to Waydoo, please provide a detailed description of the product problem. Waydoo technical support representative will attempt to diagnose and resolve the problem via e-mail or remote assistance. If the problem persists, you may need to send the product back to Waydoo or an authorized Waydoo service center for further testing. Waydoo will arrange for repair or replacement under the limited warranty.

Before obtaining warranty service for your product, please read the following terms and conditions.

- √ Follow Waydoo's service process;
- √ Agree that Waydoo shall not be held responsible for the loss or disclosure of any data, including confidential information, proprietary information, or personal information, contained in the returned product;
- √ Provide Waydoo with sufficient and safe access to your product, so Waydoo can provide service as needed;
- √ Remove all functional parts, additional parts, alterations, modified parts, and attachments not covered under this limited warranty;
- √ Ensure that the product or part is free of any legal restrictions that prevent its replacement;
- √ If you are not the owner of a product or part, obtain authorization from the owner for Waydoo to provide warranty service

Replacement Products and Parts

When after-sales service involves the replacement of a product or part, the replacement item becomes your property and the replaced item becomes Waydoo's property. Only unaltered Waydoo products and parts are eligible for replacement. Replacement products or parts may not be new, but they will be in good working order and at least functionally equivalent to the products or parts replaced. A replacement product or part shall be covered for the time remaining in the original product's warranty and bound to a new serial number.

Use of Personal Contact Information and Data

If you obtain service under this policy, you authorize Waydoo to store, use, and process your contact information, including name, phone number, address, and e-mail address. You agree and understand that it is necessary for Waydoo to collect, process and use your data to perform service under this policy. We may contact you for assistance, inquire about your satisfaction with our service, or to notify you about any product recalls or safety issues. To achieve these aims, you authorize Waydoo to transfer your information to any country where we do business and to provide it to entities acting on our behalf. We may also disclose your information where required by law.

What is NOT Covered by This After-Sales Policy?

This policy does not cover the following:

- × Parts not specified in the APPENDIX *.
- × Changes in appearance or damages caused by normal wear and tear, color change, etc.
- × Damage caused by crash, physical impact, or fire resulting from non-manufacturing factors, including but not limited to, user error.
- × Damage caused by unauthorized modification, or disassembly not in accordance with official instructions or manuals.
- × Damage caused by improper installation, incorrect use, or operation not in accordance with official instructions or manuals.
- × Damage caused by cleaning the products or parts not in accordance with official instructions or manuals.
- × Damage caused by an unauthorized service provider.
- × Damage caused by unauthorized modification of circuits and mismatch or misuse of the battery and charger.
- × Damage caused by activities not following official instructions or manuals.
- × Damage caused by operating in bad weather (i.e. strong winds, rain, sand/dust storms, direct sunlight, etc.)
- × Damage caused by operating in an unsafe or improper environment (i.e. water depth less than 1.2m, water with many gavels, seaweeds and wild animals, rocky water/shore, etc.)
- × Damage caused by a forced operation when components have deteriorated or been damaged.
- × Damage caused by reliability or compatibility issues when using unauthorized third-party parts.
- × Damage caused by operating the unit with a drained or defective battery.
- × Further damage caused by the continued use of the product after the warranty claim is submitted or the problem is reported.
- × Loss of, or damage to your data by an unauthorized product.
- × Waydoo Subnado warranties are non-transferable and are applicable to the original purchaser only.
- × Any problem that is determined not a manufacturing defect in material or workmanship after inspection by Waydoo. Or the purchaser is unable to provide valid proof of the issue source.
- × Failure of, or damage caused by, any third-party products, including those that Waydoo may provide or integrate into the Waydoo product at your request.
- × Products or parts with altered or missing serial number.

Disclaimer

√ Limited Warranty policies and related costs may vary with respect to the local laws or the corresponding Waydoo service availability in different countries/regions where Waydoo product is purchased.

√ You may need to send the faulty product(s) back to Waydoo or a Waydoo-authorized service center. Waydoo will examine the returned product(s) to identify the problem and the responsibility upon receipt of the product(s). If the problem qualifies for service under this Limited Warranty policy, Waydoo will bear the cost for repair or replacement. The customer is responsible for all shipping costs.

√ If Waydoo determines that the issue in question is not covered by this Limited Warranty policy, you will have to apply for Customer Paid Repair Service or request Waydoo to return the product(s). Waydoo will not start repair until you agree to the cost for repair quoted by Waydoo. If you disagree with the repair cost, Waydoo may return the product(s) with you burdening the return shipping cost.

√ Given the variability of Waydoo's after-sales service policies in different countries/regions, Waydoo does not provide a global warranty. Generally, customers can obtain warranty service only at a designated Waydoo authorized service center in the region where he/she purchases the product(s). However, depending on part availability and inventory status, customers may obtain cross-regional repair service at an additional charge in an authorized repair center. Waydoo will handle the customer's request at its discretion.

√ The customer is responsible for losses incurred from providing an incorrect or invalid delivery address or refusing to sign for the delivery.

√ If you want to send the product back to Waydoo by international transport, you will need to get the consent of Waydoo and bear customs duties, taxes, customs clearance, and other costs incurred in the process.

√ If the product is extremely damaged due to non-manufacturing factors, including but not limited to, crash or physical impact, its performance may be severely affected beyond repair. In this case, Waydoo will not be able to provide the repair service.

√ If the user is located in a region/country where the service is restricted due to force majeure or other objective factors, Waydoo reserves the right to charge a necessary fee.

√ Waydoo reserves the right to refuse providing warranty service if the user is unable to provide sufficient proof with which Waydoo verifies the compliance with the malfunctioning product's limited warranty.

√ Before sending your product for repair, please remove any attached customized decorations and items. Waydoo will not be responsible for any damage or loss that may occur to these customized decorations and attachments.

√ To guarantee your legal rights, please check whether your product is intact (check whether any damage has occurred to your product during transportation) when signing for its delivery. If the product has a defect, please report it to Waydoo within twenty-four (24) hours upon receiving it, or it will be deemed that the product you signed for is intact and fully functional. (According to the Freight Claim Process, damage or defects caused by transport should be reported to Waydoo or related Waydoo authorized service center. An overdue claim will not be accepted.)

√ Waydoo reserves the right to update this policy. Check the official Waydoo website for the latest version.

Limitation of Liability

WHEN RECEIVING SERVICE, WAYDOO IS RESPONSIBLE FOR LOSS OR DAMAGE TO YOUR PRODUCT ONLY WHILE IT IS IN WAYDOO'S POSSESSION OR TRANSIT, IF WAYDOO IS RESPONSIBLE FOR TRANSPORTATION.

WAYDOO IS NOT RESPONSIBLE FOR THE LOSS OR DISCLOSURE OF ANY DATA, INCLUDING CONFIDENTIAL INFORMATION, PROPRIETARY INFORMATION, OR PERSONAL INFORMATION, CONTAINED IN A PRODUCT.

UNDER NO CIRCUMSTANCES, AND NOTWITHSTANDING THE FAILURE OF THE ESSENTIAL PURPOSE OF ANY REMEDY SET FORTH HEREIN, SHALL WAYDOO, ITS AFFILIATES, SUPPLIERS, RESELLERS, OR SERVICE PROVIDERS BE LIABLE FOR ANY OF THE FOLLOWING EVEN IF INFORMED OF THEIR POSSIBILITY AND REGARDLESS OF WHETHER THE CLAIM IS BASED IN CONTRACT, WARRANTY, NEGLIGENCE, STRICT LIABILITY OR OTHER THEORY OF LIABILITY:

- 1) THIRD PARTY CLAIMS AGAINST YOU FOR DAMAGES;
- 2) LOSS, DAMAGE OR DISCLOSURE OF YOUR DATA;
- 3) SPECIAL, INCIDENTAL, PUNITIVE, INDIRECT OR CONSEQUENTIAL DAMAGES, INCLUDING BUT NOT LIMITED TO LOST PROFITS, BUSINESS REVENUE, GOODWILL OR ANTICIPATED SAVINGS. IN NO CASE SHALL THE TOTAL LIABILITY OF WAYDOO, ITS AFFILIATES, SUPPLIERS, RESELLERS, OR SERVICE PROVIDERS FOR DAMAGES FROM ANY CAUSE EXCEED THE AMOUNT OF ACTUAL DIRECT DAMAGES, NOT TO EXCEED THE AMOUNT PAID FOR THE PRODUCT.

THE FOREGOING LIMITATION DOES NOT APPLY TO DAMAGES FOR BODILY INJURY (INCLUDING DEATH), DAMAGE TO REAL PROPERTY OR DAMAGE TO TANGIBLE PERSONAL PROPERTY FOR WHICH WAYDOO IS LIABLE UNDER LAW.

AS SOME STATES OR JURISDICTIONS DO NOT ALLOW THE EXCLUSION OR LIMITATION OF INCIDENTAL OR CONSEQUENTIAL DAMAGES, THE ABOVE LIMITATION OR EXCLUSION MAY NOT APPLY TO YOU.

Your Other Rights

This Limited Warranty provides you with extra and specific legal rights. You may have other rights according to the applicable laws of your state or jurisdiction. You may also have other rights under a written agreement with Waydoo. Nothing in this Limited Warranty affects your statutory rights, including rights of consumers under laws or regulations governing the sale of consumer products that cannot be waived or limited by agreement.

For other after-sales policy details, technical support, and other requests, please e-mail Waydoo at support@waydoo.com or contact your local authorized dealers.

Appendix I warranty period

Part	Northern America	Europe	Australia	New Zealand	Other countries or areas
Main unit	1 year	2 years	1 year	1 year	1 year
Rear cover	6 months	6 months	6 months	6 months	6 months
Charger	6 months	6 months	6 months	6 months	6 months
Twin Engine Handle Bracet/Handle Bracet/Wired Thumb Controller	6 months	6 months	6 months	6 months	6 months

*The accessories are subject to the packing list of your purchased product.

*The main unit contains only the main control system, motor, and battery.

*Any parts that are not specified in the official warranty key-parts list will not enjoy this limited warranty policy.





Waydoo Technical Support

This guide may be updated without notice.

Check the official Waydoo website for the latest version

www.waydoo.com